

We ensure that systems work better.

VULKAN

Solutions for refrigeration and air conditioning technology

Vehicle Air Conditioning Repair the leak!



CONTENTS

04	VULKAN
08	LOKRING® & LOKCLIP
14	STARTER KIT
16	ASSEMBLY TOOLS
18	LOKPREP®
20	LOKRING® TUBE CONNECTIONS
24	LOKCLIP HOSE CONNECTIONS
28	O-RING REPAIR FITTINGS
30	TUBES AND ELBOWS
32	ACCESSORIES
34	LOKRING® ASSEMBLY
35	LOKCLIP ASSEMBLY
38	ONLINE-SERVICE
39	IMPRINT



VULKAN

THE VULKAN GROUP

SINCE 1979 VULKAN HAS DEVELOPED, MANUFACTURED AND MARKETED MECHANICAL TUBE JOINING SYSTEMS FOR REFRIGERANT LINES.

With five production sites, over 50 sales companies and around 1,400 employees at 18 locations worldwide, the VULKAN Group is one of the technology and market leaders in the field of marine, industrial and energy technology as well as refrigeration and air conditioning technology.

Under the slogan "We ensure that systems work better." we provide our customers with customized solutions that help to improve their systems both technically and economically.

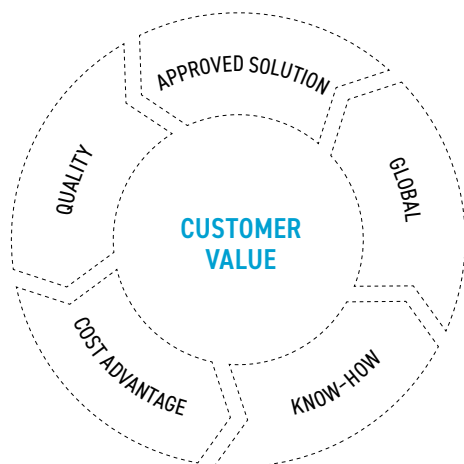

MARKETS AND PRODUCTS

Due to its diversified business portfolio, the VULKAN Group - in line with the markets it serves - is made up of three divisions: Marine, Industry and Energy and Refrigeration and Air Conditioning.

EXPERTS FOR REFRIGERATION AND AIR CONDITIONING TECHNOLOGY

Originally developed for the most extreme conditions of aerospace applications, VULKAN's LOKRING tube joining technology has been continuously developed for domestic and commercial refrigeration as well as air conditioning applications.

APPROVED SOLUTION

2,500,000,000 LOKRING® CONNECTIONS

have been successfully used in the industrial volume production of refrigerators, freezers and air conditioning systems.

GLOBAL

1,000,000 LOKRINGS PER DAY

are produced in the five international production facilities of VULKAN on modern multi-spindle automatic lathe machines and shipped to 83 destination countries.

COST ADVANTAGE

7,000 CUSTOMERS

optimise their international competitive edge by using LOKRING tube connections as cost and quality benefit compared to brazed ones.

KNOW-HOW

650 UNIQUE TYPES OF LOKRING

are used at present by customers in order to optimally join tubes made of different materials and combinations of diameters.

QUALITY

100% QUALITY INSPECTION

of LOKRING based on automated industrial image processing as part of the certified VULKAN quality management system.

THE VULKAN GROUP

CUSTOMIZED SOLUTIONS FOR BRAZE-FREE TUBE CONNECTIONS

Since 1979, we have continuously applied the expert knowledge gained as an original equipment manufacturer for the industry to our braze-free tube connections, providing customized solutions for tube connections used in the manufacture, installation and maintenance of refrigeration and air conditioning equipment. As the market leader in braze-free, permanent tube connections, we can supply a matched system of tube connections in original equipment quality and with all necessary certifications for almost any installation or service application. This also includes the corresponding assembly tools and accessories.

EVERYTHING FROM A SINGLE SOURCE

Our customers receive everything from a single source - from special development for specific customer requirements and in-house production to sales and service through local subsidiaries or authorized distributors. VULKAN's Refrigeration and Air Conditioning division is divided into the following business segments:

⊕ OEM | PRODUCTION

The LOKRING Single Ring technology is a method for connecting metallic refrigerant lines without brazing so that they are permanent and hermetically sealed. For this purpose, VULKAN constructs customised LOKRING tube connectors for any application based on the tube materials, dimensions and tolerances and the associated assembly tools. Whether it is a matter of optimising costs, improving quality, or solving a problem - LOKRING Single Ring is the answer!

⊕ INSTALLATION OF HVAC SYSTEMS

The patented LOKRING tube connection system provides an innovative system of braze-free tube connectors for every installation situation in refrigeration and air conditioning technology.

⊕ REPAIR OF REFRIGERATION APPLIANCES

VULKAN provides an innovative system of braze-free tube connectors for every repair situation in refrigeration appliances.

⊕ REPAIR OF VEHICLE A/C SYSTEMS

Our technology includes an innovative system of braze-free tube connectors as well as hose connectors for every repair situation in vehicle air conditioning systems & E-Vehicle battery cooling circuits.

RESEARCH AND DEVELOPMENT

For the last decades, experienced engineers have built new solutions for customers' applications in the development centre in Germany.

PRODUCT AND MANAGEMENT CERTIFICATION

The products of VULKAN Refrigeration and Air Conditioning have of course TÜV and UL product approval. Furthermore, the quality management system is certified according to ISO 9001 and the environmental management system according to ISO 14001. In addition, AEO certifications, leak tests and expert reports are available.

CLIMATE PROTECTION

Since our tube connections are hermetically sealed, we can ensure that no climate damaging refrigerants leak into the environment. Furthermore, LOKRING makes the use of environmental friendly but flammable refrigerants (HC) safer and allows the use of CO₂ (R744). Thus, by using LOKRING tube connections you make a contribution to the active protection of the environment.

SERVICE

Whether you are seeking planning and consultancy for optimising the refrigeration cycle system by using braze-free tube connections, support with the introduction of the LOKRING technology in production or after-sales service - everything is available locally with competent VULKAN technicians.

THE BEST CONNECTION - WORLDWIDE

Operating with five international production facilities, with 18 VULKAN subsidiaries and an additional 13 agencies worldwide, we ensure that LOKRING expertise is available on site throughout the world. This means that our customers have rapid access to our specialists and that the necessary solutions are quickly available exactly where they are needed.



CUSTOMER REFERENCES

A small selection from more than 7,000 satisfied customers:



LOKRING® & LOKCLIP

THE PATENTED LOKRING® TUBE CONNECTION SYSTEM PROVIDES AN INNOVATIVE SYSTEM OF BRAZE-FREE TUBE CONNECTIONS FOR EVERY REPAIR SITUATION IN VEHICLE AIR CONDITIONING SYSTEMS.

LOKRING tube connections can be made without a great deal of force being necessary, using simple hand assembly tools. LOKRING ensures an absolutely clean, permanent and purely mechanical tube connection with long-term hermetic air-tightness. This is confirmed by the

special TÜV test and approval. All this makes LOKRING tube connections one of the most economical and reliable methods of connecting refrigerant tubes.

THE BENEFITS

- ⊕ For universal use, independent of the vehicle type and model year
- ⊕ No waiting for expensive original spare parts
- ⊕ No welding, brazing or thread cutting necessary
- ⊕ In many cases, the faulty line may not even have to be removed
- ⊕ For more than 40 years tried-and-trusted by OEMs
- ⊕ In compliance with EU directive 2006/40/EG

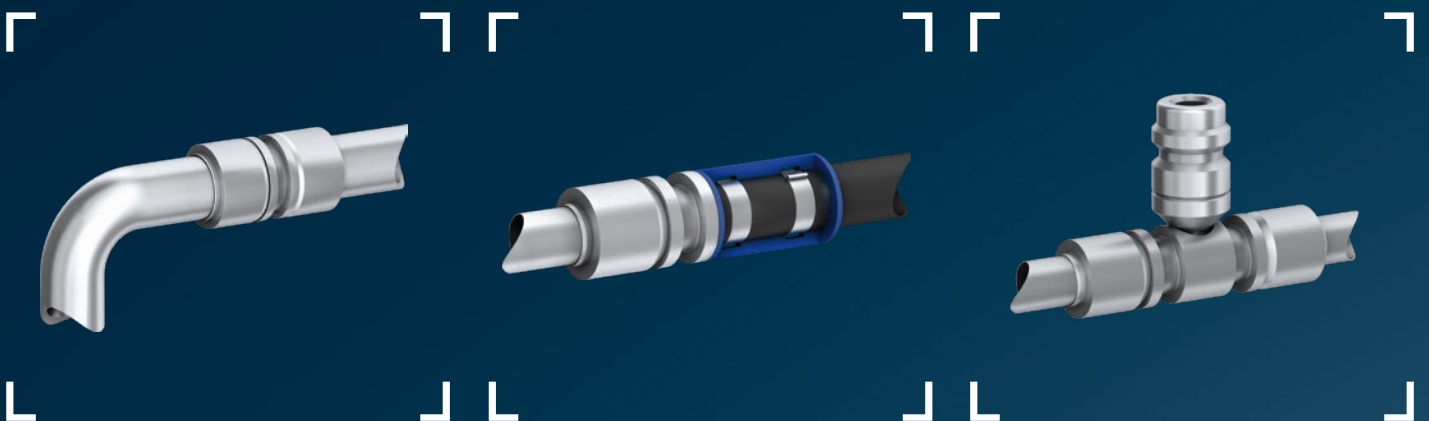
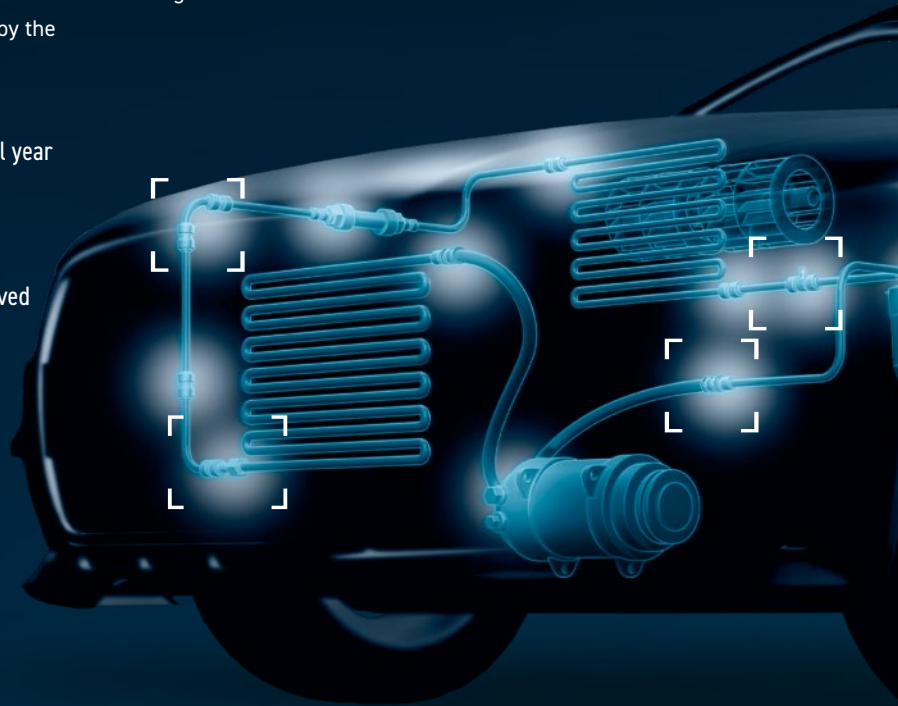

REPAIR THE LEAK!

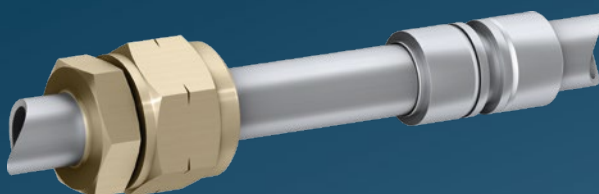
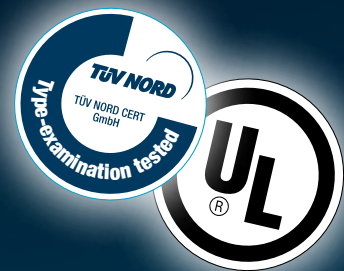

WITH LOKRING® & LOKCLIP YOU CAN REPAIR:

- ⊕ Straight tubes and elbows
- ⊕ Hoses
- ⊕ Hose-to-Tube connections
- ⊕ Pressure switch connections
- ⊕ Service ports
- ⊕ Threaded connections

LOKRING®

THE TYPICAL LOKRING union joint consists of two LOKRINGS and one tubular joint for the acceptance of the two tube ends. Thanks to the conical inner contour of the LOKRING and the special outer contour of the joint, the diameter of the connection is reduced during assembly to such an extent that the joint and the tube create a hermetically

sealed metal-to-metal connection. The lifetime gas-tightness of the fitted connection is ensured by the state of permanent elastic pre-tension, which is produced by the radial forces of the LOKRINGS acting in the opposite direction to the tube-joint connection.

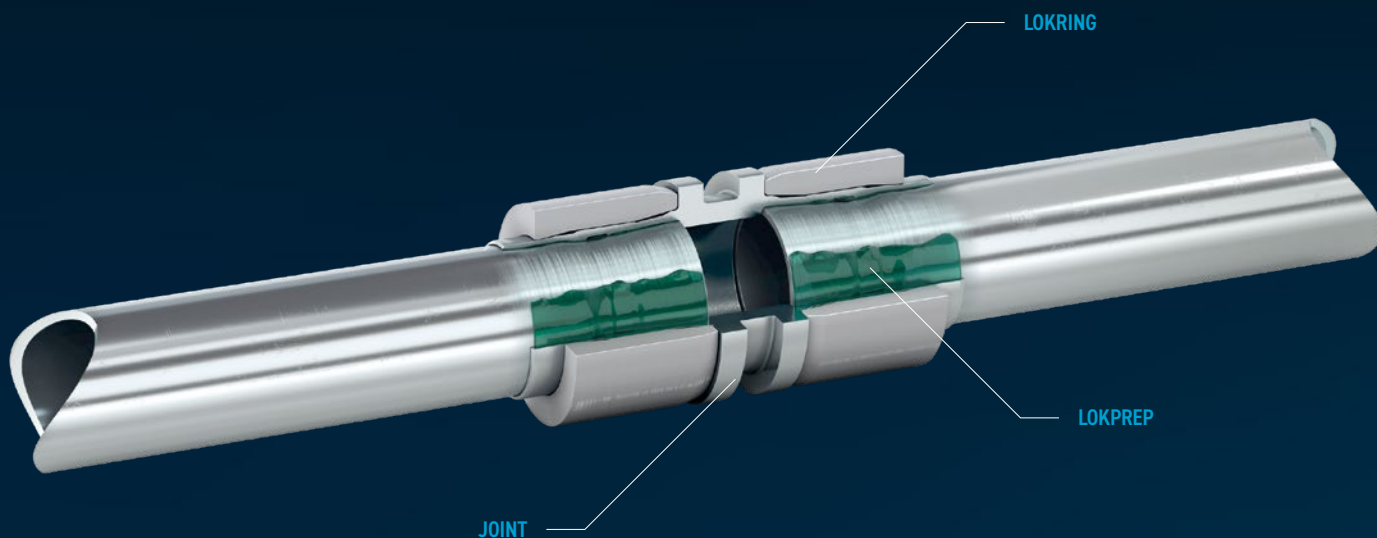

TECHNICAL SPECIFICATIONS

Reference standards:
EN 378-2 and ISO 14903

Max. operating pressure:
25 bar (360 psi)

Admissible refrigerants:
Suitable for R134a and HFO-1234yf.
Other refrigerants on request.

Temperature range:
-50 °C up to 150 °C
(-58 °F up to 302 °F)

Tube diameter range:
8 to 19 mm (5/16" to 3/4")

Material combinations:
For joining aluminium tubes.
Other tube materials on request.

Approvals:
TÜV, UL (File SA12004)

MATERIAL COMBINATIONS



 Aluminium

LOKCLIP

LOKCLIP TECHNOLOGY provides you with a simple and low-cost alternative to pressed and screwed connections for hoses. LOKCLIPs can be used to set up both hose-to-hose and hose-to-tube connections for all conceivable repair situations. The system, comprising stainless steel clips, clip position holder and contoured joint practically

excludes application mistakes during assembly. Alongside the important SAE J2064, LOKCLIPs meet all the required standards.

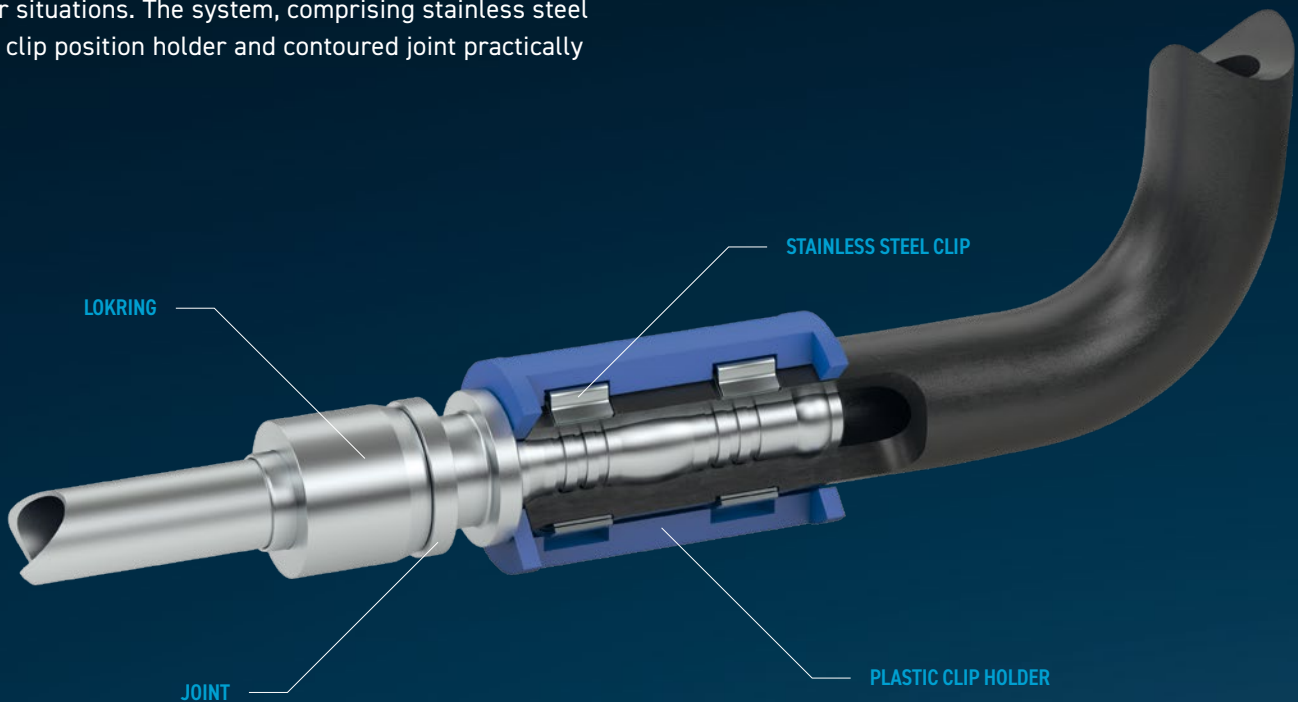

TECHNICAL SPECIFICATIONS

Max. operating pressure:
25 bar (360 psi)

Admissible refrigerants:
Suitable for R134a and HFO-1234yf.
Other refrigerants on request.

Temperature range:
-40 °C up to 135 °C
(-40 °F up to 275 °F)

Tube diameter range:
8 to 19 mm (5/16" to 3/4")

Material combinations:
For joining LOKCLIP RH refrigerant hose and aluminium tube.
Other tube materials on request.

MATERIAL COMBINATIONS



Aluminium
 Hose





LOKRING® & LOKCLIP

STARTER KIT



HAND ASSEMBLY TOOL
ASSEMBLY JAWS
LOKPREP
ABRASIVE MAT
STRAIGHT CONNECTORS



STRAIGHT REDUCING CONNECTORS
45° ALUMINIUM ELBOWS
90° ALUMINIUM ELBOWS
HOSE-TO-TUBE CONNECTORS
HOSE-TO-LOKRING CONNECTORS

LOKRING® & LOKCLIP STARTER KIT



For a perfect start in the world of quick, easy and, above all, low-cost repairs to tubes and hoses in vehicle air conditioning systems.

Article no. Article name

L13005830 LOKBOX SK-VAC-01

Scope of supply

Article no.	Article name	Description	Quantity
L13002811	LOKTOOL MZ-V	Hand assembly tool	1
L20000304	LOKTOOL MB 8 EVP	Assembly jaws	2
L20000305	LOKTOOL MB 10 EVP	Assembly jaws	2
L20000306	LOKTOOL MB 12 EVP	Assembly jaws	2
L20000307	LOKTOOL MB 16 EVP	Assembly jaws	2
L20000308	LOKTOOL MB 19 EVP	Assembly jaws	2
L14000878	LOKPREP 65G	Anaerobic sealant	1
L14002211	AM-SV	Abrasive mat	1
L13005445	LOKRING 8 NK Al 50	Straight connectors	4
L13005446	LOKRING 9,53 NK Al 50	Straight connectors	4
L13005502	LOKRING 10 NK Al 50	Straight connectors	2
L13005616	LOKRING 12 NK Al 50	Straight connectors	2
L13005447	LOKRING 12,7 NK Al 50	Straight connectors	2
L13005448	LOKRING 16 NK Al 50	Straight connectors	2
L13005501	LOKRING 18 NK Al 50	Straight connectors	2
L13005449	LOKRING 19 NK Al 50	Straight connectors	2
L13005664	LOKRING 9,53/8 NR Al 50	Straight reducing connectors	2
L13005668	LOKRING 10/9,53 NR Al 50	Straight reducing connectors	2
L13005670	LOKRING 12,7/12 NR Al 50	Straight reducing connectors	2
L13005671	LOKRING 19/18 NR Al 50	Straight reducing connectors	2
L14002234	LOKRING Al 90-EB 9,53	90° aluminium elbows	1
L14002235	LOKRING Al 90-EB 12,7	90° aluminium elbows	1
L14002236	LOKRING Al 90-EB 16	90° aluminium elbows	1
L14002231	LOKRING Al 45-EB 9,53	45° aluminium elbows	1
L14002232	LOKRING Al 45-EB 12,7	45° aluminium elbows	1
L14002233	LOKRING Al 45-EB 16	45° aluminium elbows	1
L13003869	LOKCLIP Al NK9,53-06	Hose-to-LOKRING connectors	2
L13003870	LOKCLIP Al NK12,7-08	Hose-to-LOKRING connectors	2
L13003871	LOKCLIP Al NK16-10	Hose-to-LOKRING connectors	2
L13003872	LOKCLIP Al NK19-12	Hose-to-LOKRING connectors	2
L13004400	LOKCLIP Al 9,53-06	Hose-to-tube connectors	2
L13004401	LOKCLIP Al 12,7-08	Hose-to-tube connectors	2
L13004402	LOKCLIP Al 16-10	Hose-to-tube connectors	2
L13004403	LOKCLIP Al 19-12	Hose-to-tube connectors	2

ASSEMBLY TOOLS

LOKTOOL MZ-V

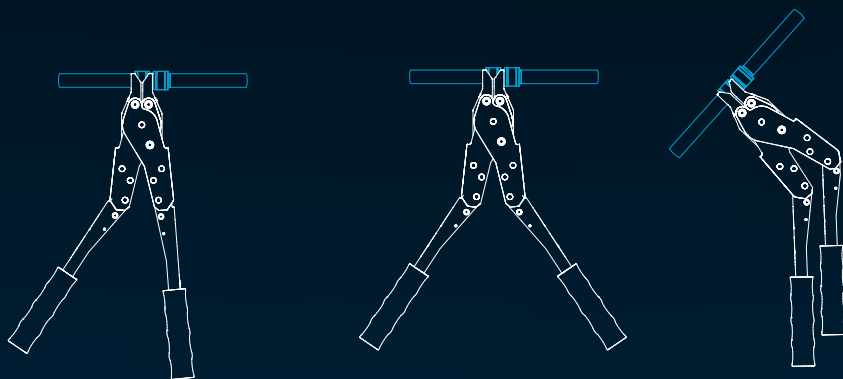

Our patented hand assembly tools were developed especially for LOKRING assembly. You only need one tool, because the assembly jaws can be exchanged quickly and easily. Since the handles are offset on both sides, the MZ-V is also suitable for flexible use during work in the engine compartment.

ASSEMBLY TOOLS

LOKRING® HAND ASSEMBLY TOOL



- ⊕ Specially developed for the LOKRING assembly.
- ⊕ Patented lever mechanism for assembly with minimum effort.
- ⊕ Assembly jaws are easy to change for different tube diameters.
- ⊕ Both handles bend for use in hard-to-reach areas.
- ⊕ Made in Germany.

IMPORTANT: Assembly jaws not included.

Article no. Article name

L13002811 LOKTOOL MZ-V

LOKRING® ASSEMBLY JAWS



Suitable for the LOKTOOL MZ-V hand assembly tool.

Article no.	Article name	For tube outer- ϕ [mm "]	
L20000304	LOKTOOL MB 8 EVP	6 - 8	1/4 - 5/16
L20000305	LOKTOOL MB 10 EVP	9 - 11	3/8
L20000306	LOKTOOL MB 12 EVP	12 - 13	1/2
L20000307	LOKTOOL MB 16 EVP	14 - 17	5/8
L20000308	LOKTOOL MB 19 EVP	18 - 20	3/4

LOKCLIP HAND ASSEMBLY TOOL



- ⊕ For crimping the stainless steel clips of a LOKCLIP hose connection.
- ⊕ Suitable for all LOKCLIP hose connections.
- ⊕ Compact design makes it easy to access even in hard-to-reach areas.

Article no. Article name

L14003352 LOKTOOL LC flex

LOKPREP® APPLICATION

LOKPREP 65G

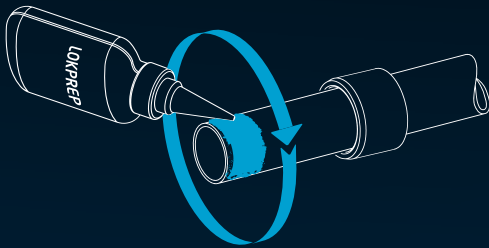

POSSIBILITY A

Move the nozzle 360° around the tube to distribute the LOKPREP evenly.

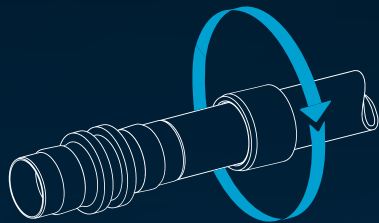

POSSIBILITY B

Rotate the moistened tube through 360° inside the joint.

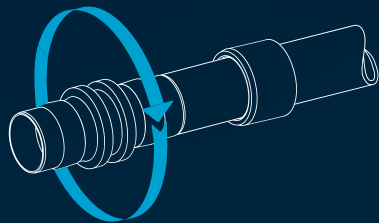

POSSIBILITY C

Rotate the joint through 360° around the end of the tube.

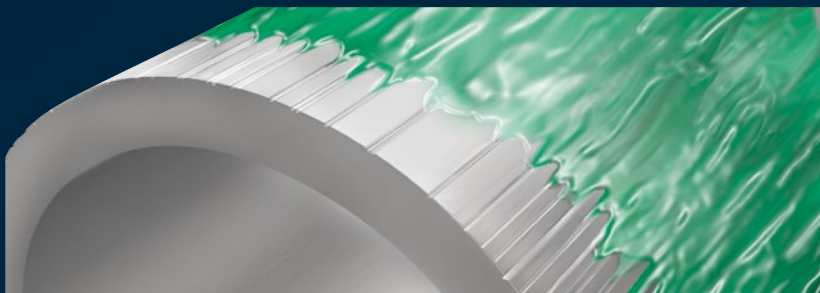

Metal tubes can have longitudinal grooves on the surface from production. These production-related faults can be compensated quite easily by moistening the tube ends to be connected with LOKPREP fluid before assembly. Thanks to its capillary characteristic, it can even flow into microscopic cavities and fill these out completely. LOKPREP is not an adhesive, rather an anaerobic sealant which hardens under oxygen exclusion and in contact with free metal ions.

LOKPREP®



ANAEROBIC SEALANT



- ⊕ Specially developed for the LOKRING assembly.
- ⊕ Must be used for all LOKRING assemblies.
- ⊕ Compensates for any unevenness in the tube surface.
- ⊕ Ensures that every LOKRING connection is hermetically sealed.

IMPORTANT: LOKPREP 65G is suitable for aluminium tubes. Other tube materials on request.

Article no.	Article name	Content [ml]
L14000878	LOKPREP 65G	15

LOKRING[®]

LOKRING STRAIGHT CONNECTORS

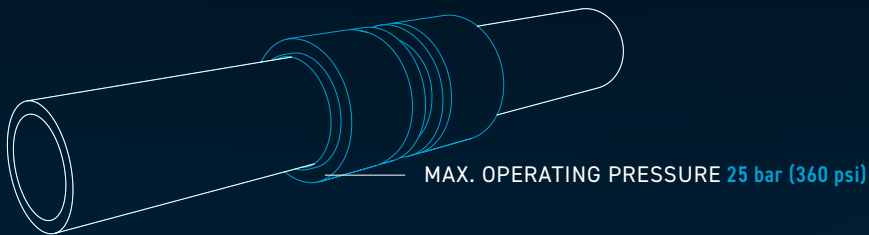

- ⊕ CORROSION TEST ACCORDING TO [ISO 9227 NSS](#)
- ⊕ TEMPERATURE CHANGE [CYCLE TEST](#)
- ⊕ TENSILE TEST ACCORDING TO [DIN EN 10 002](#)
- ⊕ TESTED ACCORDING TO EU DIRECTIVE [2006/40/EG](#)
- ⊕ ALTERNATING PRESSURE TEST WITH [250,000 CYCLES](#)
- ⊕ BURST PRESSURE TEST UP TO [200 bar \(2,900 psi\)](#)
- ⊕ REFERENCE STANDARDS [EN 378-2 AND ISO 14903](#)

STRAIGHT CONNECTORS



STRAIGHT CONNECTORS



For connecting aluminium tubes with identical outer diameters.

Article no.	Article name	For tube outer- ϕ	
		[mm]	["]
L13005445	LOKRING 8 NK Al 50	8	5/16
L13005446	LOKRING 9,53 NK Al 50	9.53	3/8
L13005502	LOKRING 10 NK Al 50	10	-
L13005616	LOKRING 12 NK Al 50	12	-
L13005447	LOKRING 12,7 NK Al 50	12.7	1/2
L13005564	LOKRING 15 NK Al 50	15	-
L13005448	LOKRING 16 NK Al 50	16	5/8
L13005501	LOKRING 18 NK Al 50	18	-
L13005449	LOKRING 19 NK Al 50	19	3/4

LOKRING® TUBE CONNECTIONS

STRAIGHT REDUCING CONNECTORS



For connecting aluminium tubes with different outer diameters.

Article no.	Article name	Outer- ϕ tube 1		Outer- ϕ tube 2	
		[mm "]		[mm "]	
L13005664	LOKRING 9,53/8 NR Al 50	9.53	3/8	→ 8	-
L13005668	LOKRING 10/9,53 NR Al 50	10	-	→ 9.53	3/8
L13005452	LOKRING 12,7/9,53 NR Al 50	12.7	1/2	→ 9.53	3/8
L13005670	LOKRING 12,7/12 NR Al 50	12.7	1/2	→ 12	-
L13005453	LOKRING 16/12,7 NR Al 50	16	5/8	→ 12.7	1/2
L13005663	LOKRING 16/15 NR Al 50	16	5/8	→ 15	-
L13005454	LOKRING 19/16 NR Al 50	19	3/4	→ 16	5/8
L13005671	LOKRING 19/18 NR Al 50	19	3/4	→ 18	-

CONNECTORS WITH R134a LOW PRESSURE PORT CONNECTIONS



- ⊕ For replacing defective R134a low pressure port connections.
- ⊕ Also suitable for converting an air conditioning system from R12 to R134a.
- ⊕ End cap included.

Article no.	Article name	For tube outer- ϕ [mm "]
L13001428	LOKRING AI LP-NK12,7	12.7 1/2
L13001377	LOKRING AI LP-NK16	16 5/8

LOKCLIP

LOKCLIP STRAIGHT CONNECTORS

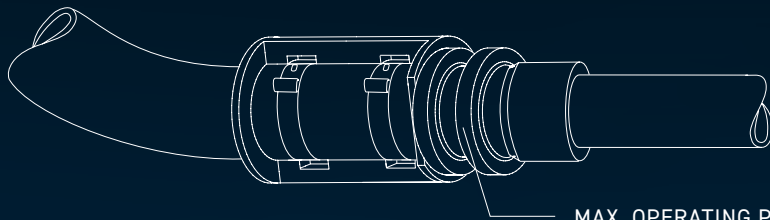

MAX. OPERATING PRESSURE 25 bar (360 psi)

- ⊕ TESTED ACCORDING TO EU DIRECTIVE 2006/40/EG
- ⊕ TEMPERATURE RANGE -40 °C UP TO 135 °C (-40 °F UP TO 275 °F)
- ⊕ BURST PRESSURE TEST UP TO 121 bar (1755 psi)

HOSE-TO-LOKRING[®] CONNECTORS



HOSE-TO-LOKRING[®] CONNECTORS



- ⊕ For assembling hose-to-tube connections.
- ⊕ Plastic clip holder and two stainless steel clips included.

IMPORTANT: The LOKCLIP hose connections have been specially designed for the LOKCLIP RH refrigerant hose. We cannot accept any liability for use with other refrigerant hoses.

Article no.	Article name	For tube outer- ϕ		For hose size
		[mm]	["]	
L13003869	LOKCLIP Al NK9,53-06	9.53	3/8	06
L13003870	LOKCLIP Al NK12,7-08	12.7	1/2	08
L13003871	LOKCLIP Al NK16-10	16	5/8	10
L13003872	LOKCLIP Al NK19-12	19	3/4	12

LOKCLIP HOSE CONNECTIONS

HOSE-TO-TUBE CONNECTORS



- ⊕ For assembling hose-to-tube connections.
- ⊕ Can be used with LOKRING aluminium connectors and reducing connectors.
- ⊕ Plastic clip holder and two stainless steel clips included.

IMPORTANT: The LOKCLIP hose connections have been specially designed for the LOKCLIP RH refrigerant hose. We cannot accept any liability for use with other refrigerant hoses.

Article no.	Article name	Tube outer- ϕ [mm "]	For hose size
L13004400	LOKCLIP Al 9,53-06	9.53 3/8	→ 06
L13004401	LOKCLIP Al 12,7-08	12.7 1/2	→ 08
L13004402	LOKCLIP Al 16-10	16 5/8	→ 10
L13004403	LOKCLIP Al 19-12	19 3/4	→ 12

HOSE CONNECTORS (SPLICER)



- ⊕ For connecting hoses with identical inner diameters.
- ⊕ Two plastic clip holders and four stainless steel clips included.

IMPORTANT: The LOKCLIP hose connections have been specially designed for the LOKCLIP RH refrigerant hose. We cannot accept any liability for use with other refrigerant hoses.

Article no.	Article name	For hose size
L13004219	LOKCLIP Splicer 06-06	06
L13004220	LOKCLIP Splicer 08-08	08
L13004221	LOKCLIP Splicer 10-10	10
L13004222	LOKCLIP Splicer 12-12	12

HOSE-TO-TUBE CONNECTORS FOR STANDARD BARRIER HOSE



- ⊕ For assembling hose-to-tube connections.
- ⊕ Can be used with LOKRING aluminium connectors and reducing connectors.
- ⊕ Suitable for refrigerant hoses with standard wall thickness.
- ⊕ Not suitable for film tubes.
- ⊕ A special clamping tool is required for assembling the hose connection.

Article no.	Article name	Tube outer- ϕ [mm "]	For hose size
L14000751	HOSELOK Al 9,53-06	9.53 3/8	→ 06
L14000872	HOSELOK Al 12,7-08	12.7 1/2	→ 08
L14000879	HOSELOK Al 16-10	16 5/8	→ 10
L14000873	HOSELOK Al 19-12	19 3/4	→ 12

STAINLESS STEEL CLIPS FOR LOKCLIP HOSE CONNECTIONS



For crimping the LOKCLIP RH refrigerant hose with the joint of a LOKCLIP hose connection.

Article no.	Article name	For hose size
L14002804	LOKCLIP SSC 06	06
L14002805	LOKCLIP SSC 08	08
L14002806	LOKCLIP SSC 10	10
L14002807	LOKCLIP SSC 12	12

PLASTIC CLIP HOLDERS FOR LOKCLIP HOSE CONNECTIONS



Ensures the stainless steel clips of a LOKCLIP hose connection are in the right place.

Article no.	Article name	For hose size
L14002808	LOKCLIP PCH 06	06
L14002809	LOKCLIP PCH 08	08
L14002810	LOKCLIP PCH 10	10
L14002811	LOKCLIP PCH 12	12

REFRIGERANT HOSE SET FOR LOKCLIP HOSE CONNECTIONS



Two-metre length of hose in each of the four sizes: 06, 08, 10 and 12.

Article no.	Article name
L13004937	LOKCLIP GA LCS

REFRIGERANT HOSE FOR LOKCLIP HOSE CONNECTIONS



⊕ Refrigerant hose in OEM quality specially designed for the LOKCLIP hose connections. ⊕ Material sold by the metre.

⊕ Temperature range -40 °C up to 135 °C (-40 °F up to 275 °F) ⊕ Operating pressure 34.50 bar (500 psi)

IMPORTANT: If this refrigerant hose is used correctly in conjunction with the LOKCLIP hose connections, we guarantee 100 percent quality and tightness. We cannot accept any liability for products from other manufacturers.

Article no.	Article name	Hose inner- ϕ [mm]	Hose outer- ϕ [mm]	Burst pressure [bar psi]	Bending radius [mm]	Hose size
L14002664	LOKCLIP RH R134a R06	7.90 - 8.60	14.20 - 15.20	172 2495	25	06
L14002665	LOKCLIP RH R134a R08	10.20 - 11.20	16.80 - 17.80	172 2495	38	08
L14002666	LOKCLIP RH R134a R10	12.50 - 13.50	18.90 - 19.90	121 1755	51	10
L14002667	LOKCLIP RH R134a R12	15.60 - 16.50	23.10 - 24.10	121 1755	76	12

REPLACEMENT OF FAULTY THREADS

O-RING REPAIR FITTING

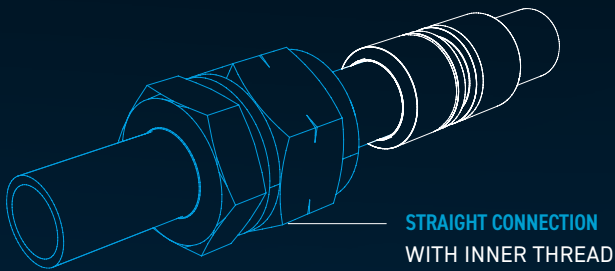

You can use these connections together with LOKRING or LOKCLIP connectors to replace faulty threads. If you should damage a thread during servicing (e.g. while replacing a condenser), it is no longer necessary to replace the whole tube. You can simply repair this again with the O-ring repair connections.

O-RING REPAIR FITTINGS

STRAIGHT CONNECTIONS WITH INNER THREAD



LOKRING aluminium O-ring repair connections with union nut (female thread).

Article no.	Article name	Tube outer- ϕ [mm "]		Thread
L14002599	LOKRING Al OR 5/8-F-9,53	9.53	3/8	5/8" - 18
L14004083	LOKRING Al OR M20x1,5-F-12.7	12.7	1/2	M20 - 1.5
L14002601	LOKRING Al OR 7/8-F-16	16	5/8	7/8" - 14
L14002602	LOKRING Al OR 1 1/16-F-19	19	3/4	1 1/16" - 14

STRAIGHT CONNECTIONS WITH OUTER THREAD (MALE INSERT)



LOKRING aluminium O-ring repair connections "male insert" with union nut (male thread).

Article no.	Article name	Tube outer- ϕ [mm "]		Thread
L14002595	LOKRING Al OR 5/8-MI-9,53	9.53	3/8	5/8" - 18
L14002596	LOKRING Al OR 3/4-MI-12.7	12.7	1/2	3/4" - 16
L14002597	LOKRING Al OR 7/8-MI-16	16	5/8	7/8" - 14
L14002598	LOKRING Al OR 1 1/16-MI-19	19	3/4	1 1/16" - 14

90° ELBOWS WITH INNER THREAD



LOKRING aluminium O-ring repair connections with 90° elbow and union nut (female thread).

Article no.	Article name	Tube outer- ϕ [mm "]		Thread
L14003335	LOKRING Al OR 90° 5/8-F-9,53	9.53	3/8	5/8" - 18
L14003336	LOKRING Al OR 90° 3/4-F-12,7	12.7	1/2	3/4" - 16
L14003337	LOKRING Al OR 90° 7/8-F-16	16	5/8	7/8" - 14

O-RINGS FOR O-RING REPAIR FITTINGS



- ⊕ Suitable for LOKRING aluminium O-ring repair fittings.
- ⊕ Cross section: 1.78 mm

Article no.	Article name	Outer- ϕ [mm]
L14003399	O-Ring 06	7.65
L14003400	O-Ring 08	10.82
L14003401	O-Ring 10	14.00
L14003402	O-Ring 12	17.17

TUBES AND ELBOWS

TUBES AND ELBOWS

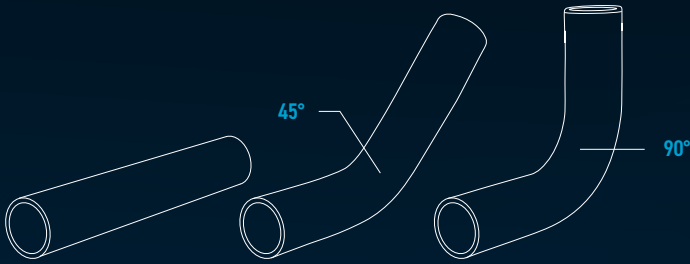

Aluminium tubes in OEM quality. For replacing aluminium tubes. Can be used with all LOKRING aluminium connectors as well as LOKCLIP connectors.

TUBES AND ELBOWS

ALUMINIUM TUBE SET



One-metre length of aluminium tube in each of the eight most popular diameters: 8 mm (5/16"); 9.53 mm (3/8"); 10 mm; 12 mm; 12.7 mm (1/2"); 16 mm (5/8"); 18 mm and 19 mm (3/4").

Article no. Article name

L13004936 LOKRING GA LRR

ALUMINIUM TUBES



- ⊕ Aluminium tubes in OEM quality.
- ⊕ Length: 1 metre.

Article no.	Article name	Tube outer- ϕ [mm "]	Article no.	Article name	Tube outer- ϕ [mm "]
L14000898	LOKRING Al TU 8	8 5/16	L14000767	LOKRING Al TU 12,7	12.7 1/2
L14000766	LOKRING Al TU 9,53	9.53 3/8	L14000765	LOKRING Al TU 16	16 5/8
L14003343	LOKRING Al TU 10	10 -	L14003780	LOKRING Al TU 18	18 -
L14000716	LOKRING Al TU 12	12 -	L14000768	LOKRING Al TU 19	19 3/4

90° ALUMINIUM ELBOWS



- ⊕ For replacing aluminium tubes with a 90° elbow.
- ⊕ Can be used with all LOKRING aluminium connectors as well as LOKCLIP connectors.

Article no.	Article name	Tube outer- ϕ [mm "]
L14002234	LOKRING Al 90-EB 9,53	9.53 3/8
L14002235	LOKRING Al 90-EB 12,7	12.7 1/2
L14002236	LOKRING Al 90-EB 16	16 5/8
L14002654	LOKRING Al 90-EB 19	19 3/4

45° ALUMINIUM ELBOWS



- ⊕ For replacing aluminium tubes with a 45° elbow.
- ⊕ Can be used with all LOKRING aluminium connectors as well as LOKCLIP connectors.

Article no.	Article name	Tube outer- ϕ [mm "]
L14002231	LOKRING Al 45-EB 9,53	9.53 3/8
L14002232	LOKRING Al 45-EB 12,7	12.7 1/2
L14002233	LOKRING Al 45-EB 16	16 5/8

ACCESSORIES

TUBE DEBURRER

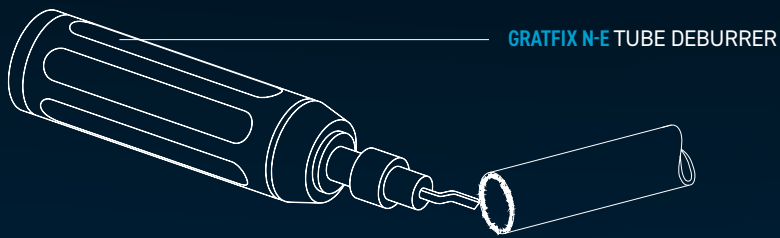

For quick and clean deburring of tubes, edges and steel plates.

ACCESSORIES

ABRASIVE MAT



- ⊕ For cleaning tube ends without scratching.
- ⊕ Suitable for all surfaces.
- ⊕ Solvent-resistant.
- ⊕ Dimensions: 158 mm x 224 mm
- ⊕ Highest quality from 3M.

Article no.	Article name
L14002211	AM-SV

TUBE DEBURRER



For quick and clean deburring of tubes, edges and steel plates.

Article no.	Article name	Description
L14001362	GRATFIX N-E	Tube deburrer
L14001363	N-E100	Replacement blade

TUBE CUTTER



Diameter range: 3 to 16 mm (1/8" to 5/8").

Article no.	Article name	Description
L14001102	TC-1050	Tube cutter
L14001103	TCS-1050	Cutting blade

HOSE CUTTER



- ⊕ For cutting refrigerant hoses.
- ⊕ Suitable for all common hose diameters in vehicle air conditioning systems.
- ⊕ Not suitable for foil hoses.

Article no.	Article name
L14000672	HC 6.12

LOKRING[®] ASSEMBLY TYPE 50

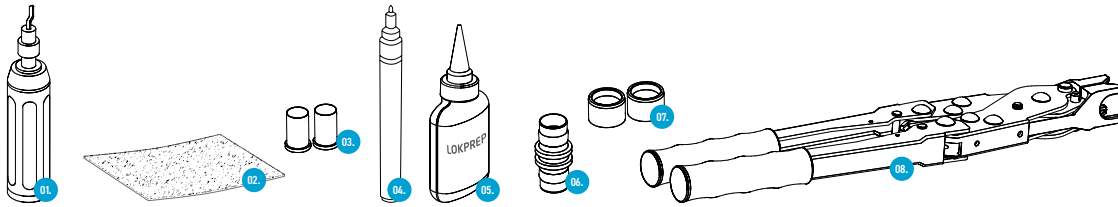

01. TUBE DEBURRER 02. ABRASIVE MAT 03. STABILISATION INSERTS 04. PERMANENT MARKER 05. LOKPREP 06. JOINT 07. LOKRINGS 08. HAND ASSEMBLY TOOL WITH ASSEMBLY JAWS MB EVP

! Deburr the tube end all the way round using a tube deburrer (01). Use different deburring tools for different materials.

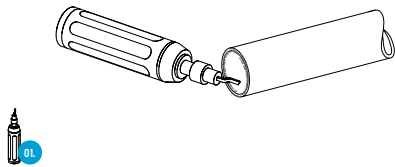

! Clean the tube end by rubbing it in rotary movements using the abrasive mat (02).

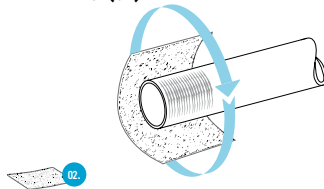

! Determine the tube wall thickness S and the outer tube diameter \varnothing on the basis of tube coding or using a slide gauge.

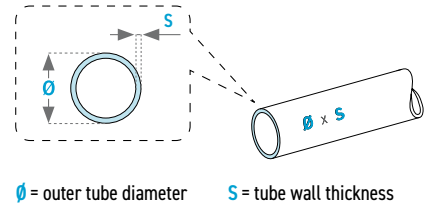

1 Insert a stabilisation insert (03) suitable for the material, the outer tube diameter \varnothing and tube wall thickness S . Stabilisation inserts (03) may not be necessary in case of use with refrigerants with an operating pressure lower than 25 bar (e.g. R134a car A/C systems or refrigerator cabinets).

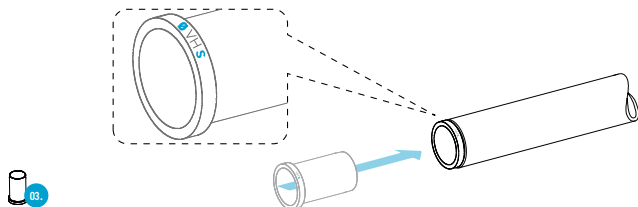

2 Before applying the LOKPREP (05), push the joint (06) onto the tube until you can feel the inner stop. Mark (04) the correct insertion depth on the tube.

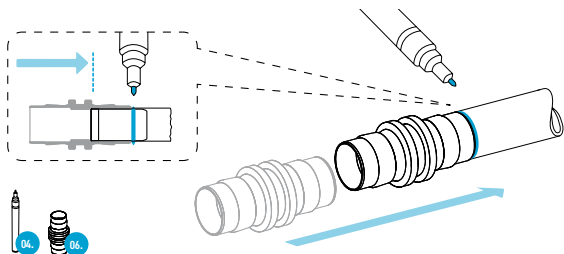

3 Choose the correct LOKPREP (05) for the tube material and the ambient temperature. Apply LOKPREP (05) all the way round the sealing area of the tube end. Respect the correct curing time of the LOKPREP (05).

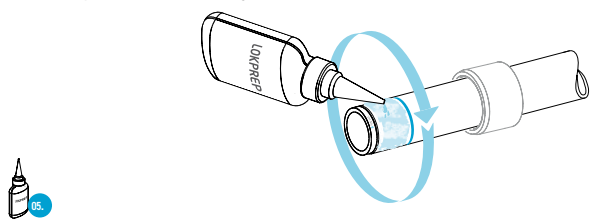

4 Push the joint (06) onto the tube until it reaches the inner stop **!**

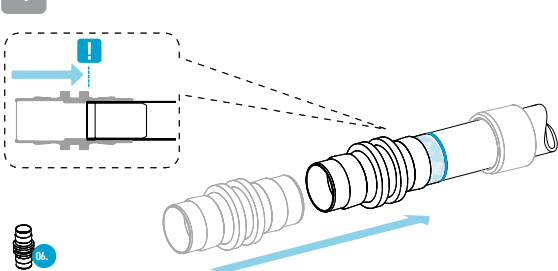

5 Put the assembly jaws (08) in place behind the LOKRING (07) and the assembly stop of the joint (06). Press the tube connection together. **!** Do not change the insertion depth of the tube and joint (06). Press the tube connection until the LOKRING (07) is flush to the assembly stop of the joint (06). Respect the curing time of the LOKPREP (05) before applying forces to the connection.

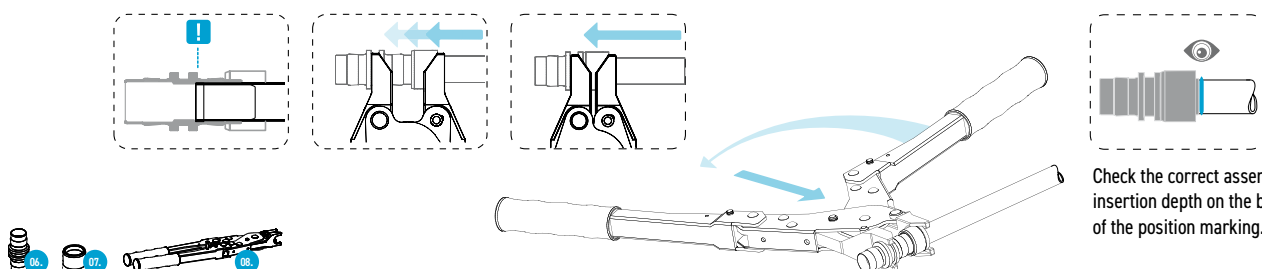

LOKCLIP ASSEMBLY

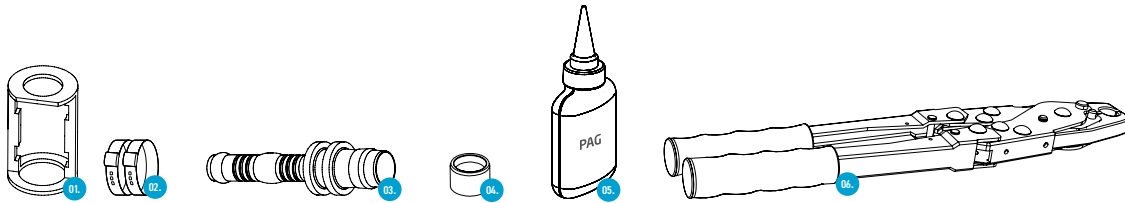

01. CLIP POSITION HOLDER 02. STAINLESS STEEL CLIPS 03. JOINT 04. LOKRING 05. REFRIGERANT OIL 06. HAND ASSEMBLY TOOL

1 Insert the two stainless steel clips (02) into the clip position holder (01).

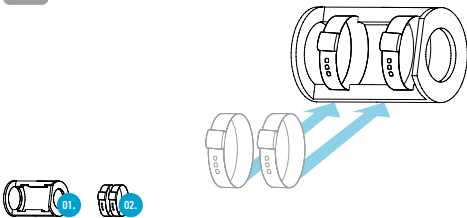

3 Lubricate the joint (03) with a little refrigerant oil (05).

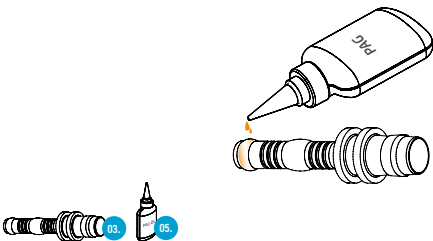

2 Insert the hose into the clip position holder (01) as far as it will go.

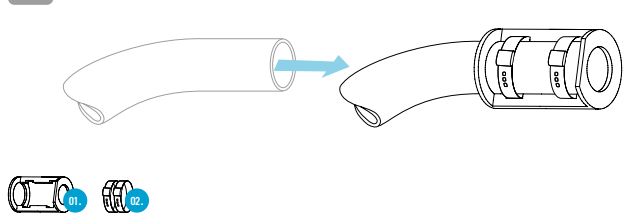

4 Push the joint (03) into the hose as far as it will go.

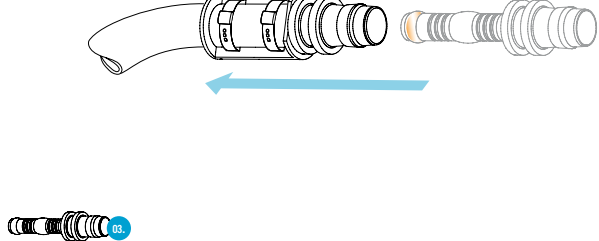

5 Press the stainless steel clips (02) using the hand assembly tool (06). Start with the clip positioned at the side of the hose. As an alternative to the hand assembly tool (06) LOKTOOL MZ-V you can also use the LOKTOOL LC flex (L14003352).

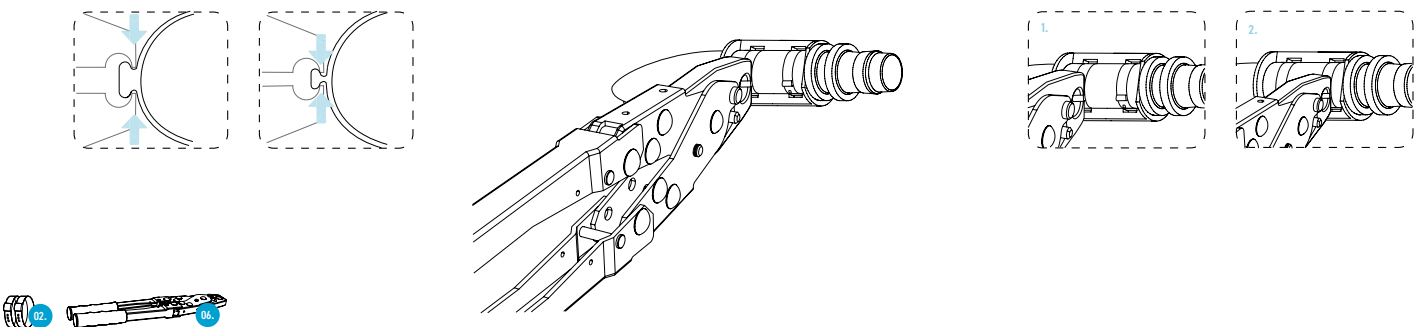

6 Now you can make the LOKRING® connection. Respect the assembly instructions for LOKRING® tube connection assembly version 50 on www.vulkan.com.

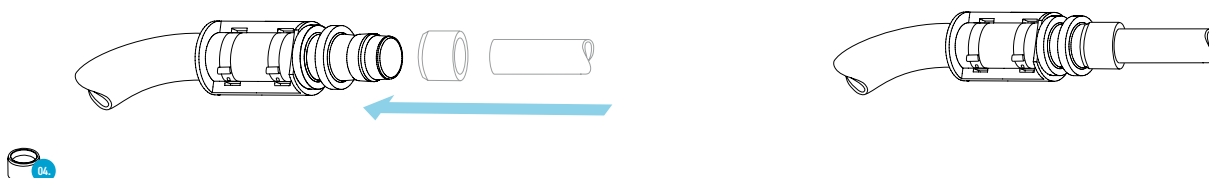

NOTES

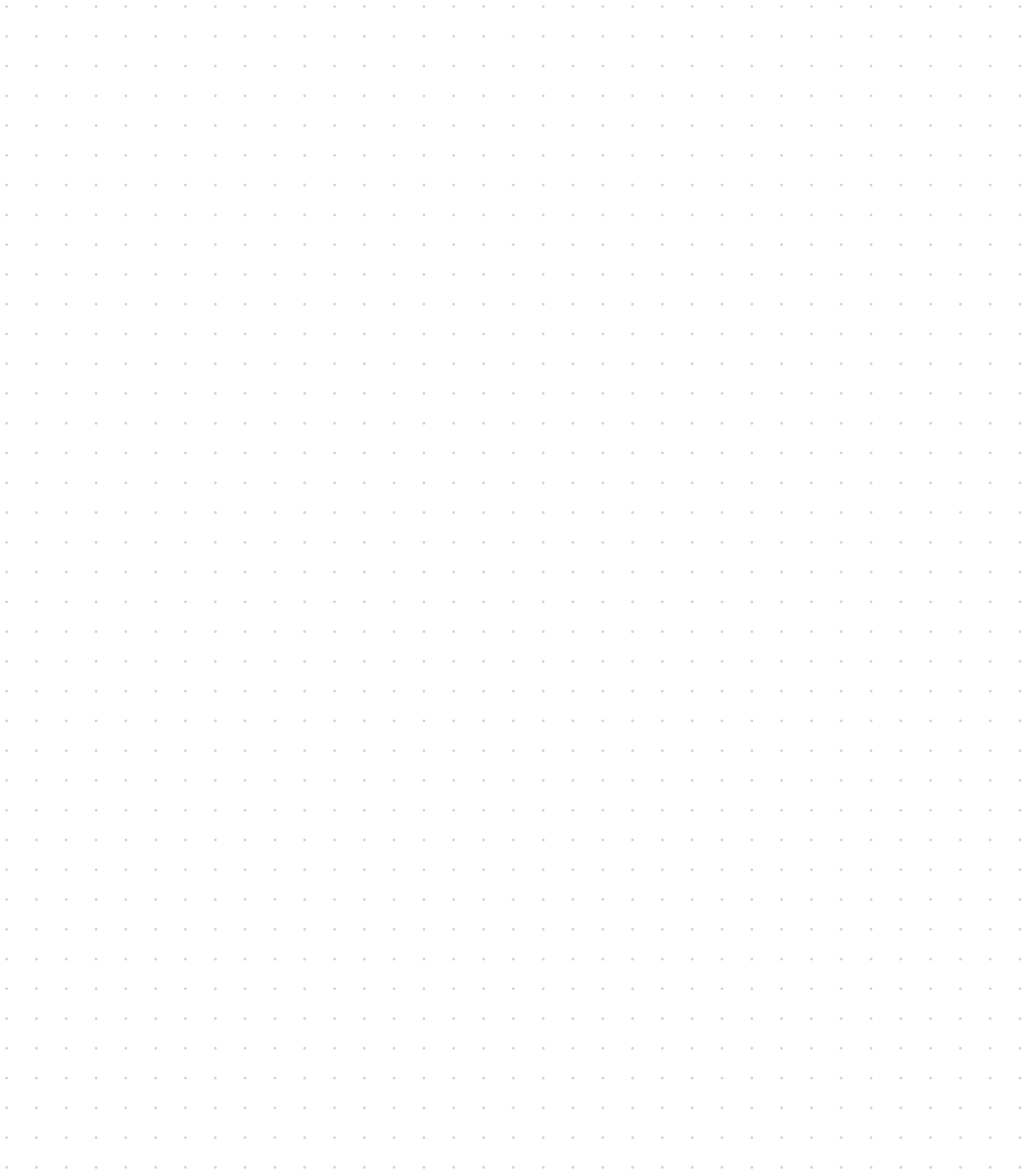

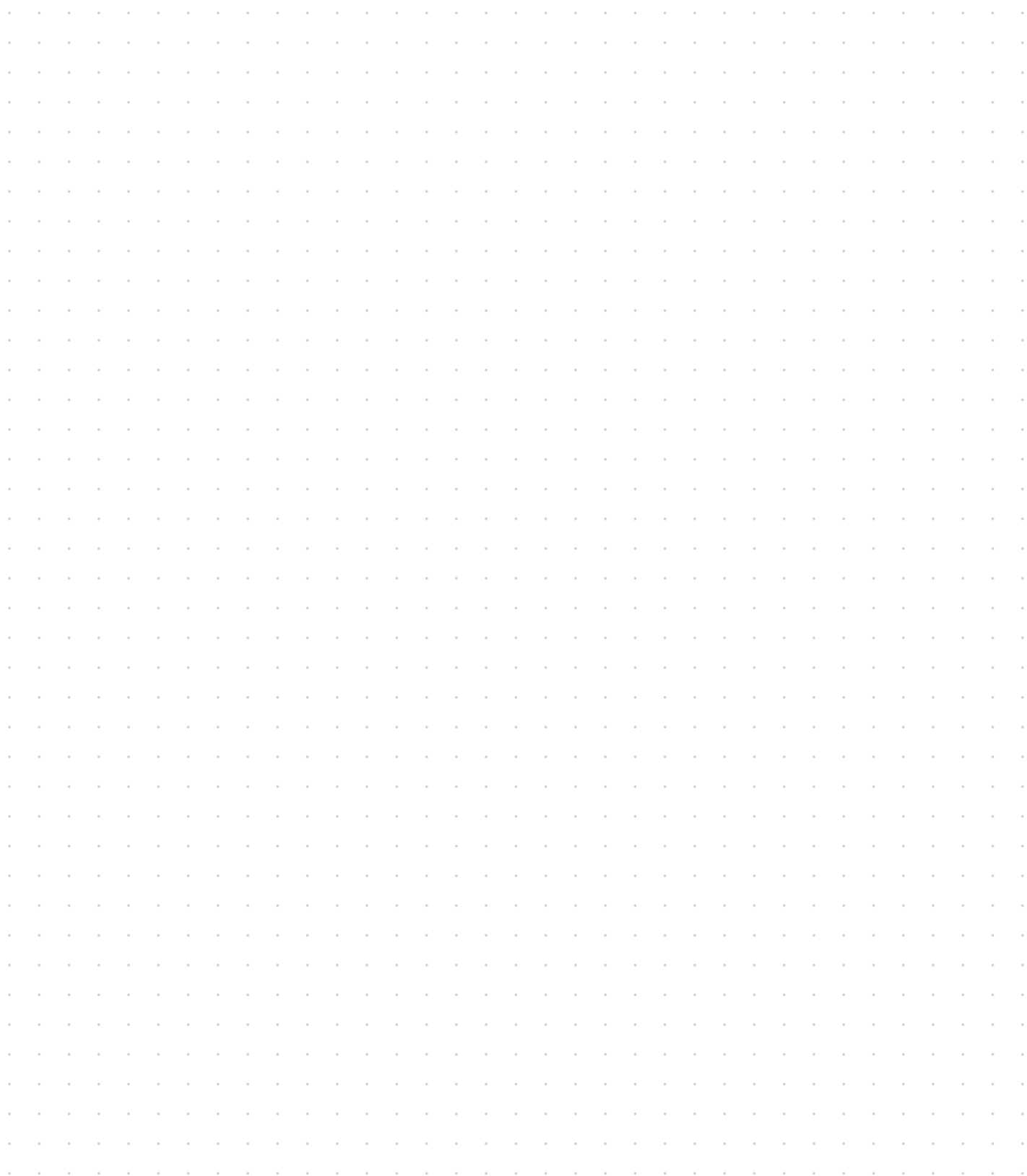

ONLINE-SERVICE

FOR FURTHER INFORMATION, PLEASE REFER
TO OUR WEBSITE WWW.VULKAN.COM



AUTHORISED DISTRIBUTORS

www.vulkan.com/en-us/lokring/contact/



VIDEOS

www.vulkan.com/en-us/lokring/videos/



TECHNICAL DOCUMENTATION AND SUBMITTAL

www.vulkan.com/en-us/lokring/downloads/technical-documentation-and-submittal



CATALOGUES & BROCHURES

www.vulkan.com/en-us/lokring/downloads/



CERTIFICATES

www.vulkan.com/en-us/lokring/downloads/certificates/

IMPRINT

PUBLISHER:

VULKAN Lokring
Rohrverbindungen GmbH & Co. KG
Heerstraße 66, 44653 Herne / Germany
Tel.: + 49 (23 25) 922-155
E-mail: info.lok@vulkan.com

CONCEPT AND DESIGN:

Hackforth Holding GmbH & Co. KG
VULKAN Marketing
Heerstraße 66, 44653 Herne / Germany
E-mail: marketing@vulkan.com

PREPRESS:

Hackforth Holding GmbH & Co. KG
VULKAN Marketing
Heerstraße 66, 44653 Herne / Germany
E-mail: marketing@vulkan.com

VALIDITY CLAUSE

The LOKRING® tube connection technology represents a proven method of producing hermetically sealed metal-to-metal tube connections. The LOKRING® tube connections are mainly used in the refrigeration and air conditioning industries. The use of LOKRING® tube connection technology in other fields is to be discussed with VULKAN. VULKAN as the supplier is responsible for the qualitative delivery of the tube connections and tools which are ordered from this catalogue.

The purchaser is responsible for the use of the LOKRING® tube connections and tools as directed. The assembly has to be done accordingly to the instructions and exclusively with original LOKRING® parts. The present catalogue shall replace all previous editions, any previous printings shall no longer be valid. The data contained in this catalogue refers to the valid state of affairs in time of the copy deadline. Any changes due to technical progress are reserved.

Status: 07/2023

All duplication, reprinting and translation rights are reserved. Further remarks for the LOKRING® assembly are available on request.

Article no.: L19000095

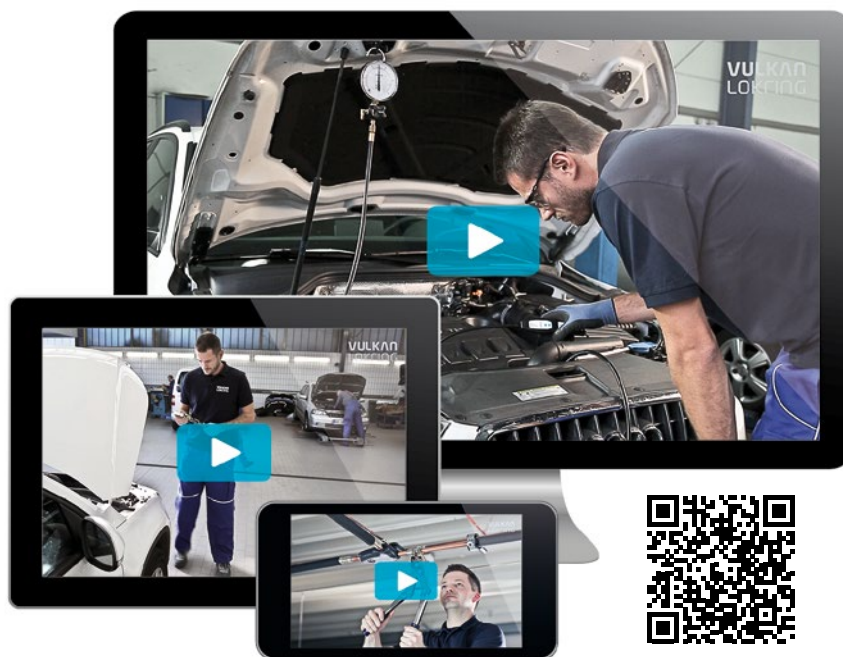

www.vulkan.com/en-us/lokring/videos/